

# BIP

B100QU / \*B200QU / B100A5 / \*B200A5 /

B100A4 / \*B200A4 / B100A3 / \*B200A3

Single or double sided (\*) floor stand support.  
Steel structure and powder coated aluminium sheet.

Soles in shockproof polystyrene, fixing hands in nylon.

Panel has a reusable adhesive area for ease in positioning sheets and a Plexiglas sheet protection.

These elements are equipped with a 90° rotating mechanism for horizontal and vertical sheets.

B100X4 / \*B200X4

Single or double sided (\*) multiple floor stand support for 4 horizontal A4 sheets communication.  
Steel structure and powder coated aluminium sheet.

Soles in shockproof polystyrene, fixing hands in nylon.

Panel has a reusable adhesive area for ease in positioning sheets and a Plexiglas sheet protection.

B100PP / \*B200PP

Single or double sided (\*) communication support floor stand for cm 50x70 sheet.  
Steel structure and powder coated aluminium sheet.

Soles in shockproof polystyrene, fixing hands in nylon.

Panel has a reusable adhesive area for ease in positioning sheets and a Plexiglas sheet protection.



## Art. B100QU

Net weight: kg. 9,5  
Packing: 1 piece

## Art. B200QU\*

Net weight: kg. 10  
Packing: 1 piece

## Art. B100A5

Net weight: kg. 9,5  
Packing: 1 piece

## Art. B200A5\*

Net weight: kg. 10  
Packing: 1 piece

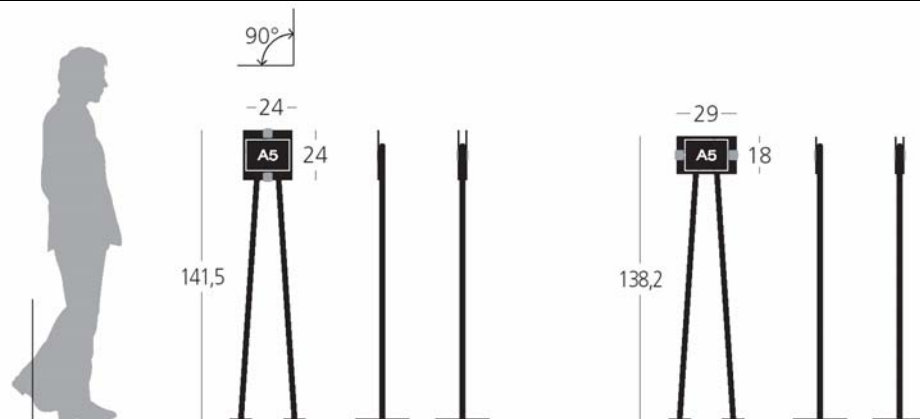

**Delight by Tecnoforma srl**  
53036 Poggibonsi (SI) Italy  
Via Umbria, 2/4  
T. ++39 0577 980333  
F. ++39 0577 938090  
[tecnoforma@delight.it](mailto:tecnoforma@delight.it)  
[www.delight.it](http://www.delight.it)

**Showroom**  
20122 Milano Italy  
Via Felice Cavallotti, 15  
T. ++39 02 76018061  
F. ++39 02 76406579  
[segismilano@segis.it](mailto:segismilano@segis.it)

# BIP

**Art. B100A4**  
 Net weight: kg. 9,6  
 Packing: 1 piece

**Art. B200A4\***  
 Net weight: kg. 10,2  
 Packing: 1 piece

**Art. B100A3**  
 Net weight: kg. 9,6  
 Packing: 1 piece

**Art. B200A3\***  
 Net weight: kg. 11,1  
 Packing: 1 piece

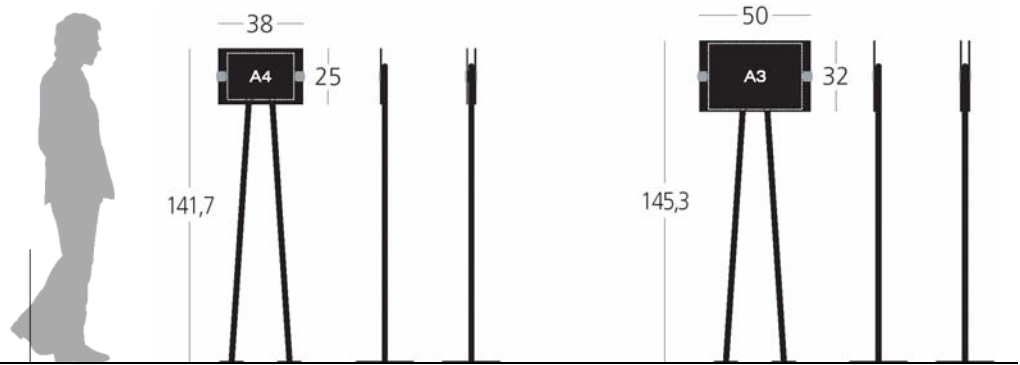

**Art. B100X4**  
 Net weight: kg. 16,5  
 Packing: 1 piece

**Art. B200X4\***  
 Net weight: kg. 21  
 Packing: 1 piece

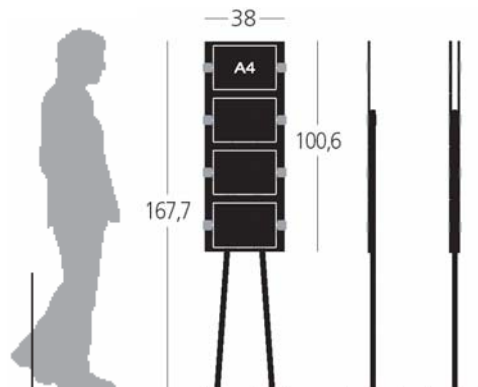

**Art. B100PP**  
 Net weight: kg. 14  
 Packing: 1 piece – 2 boxes

**Art. B200PP**  
 Net weight: kg. 19  
 Packing: 1 piece – 2 boxes

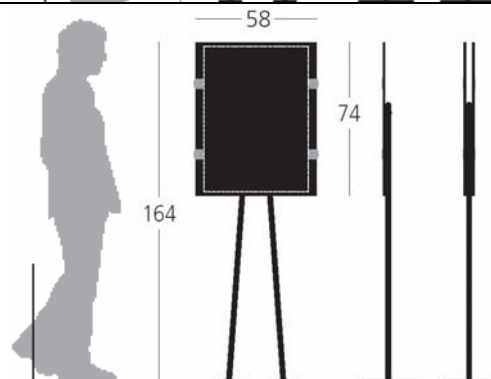

**Finishing:**

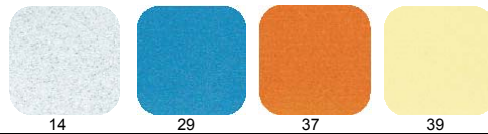

**Hands and soles colours:**

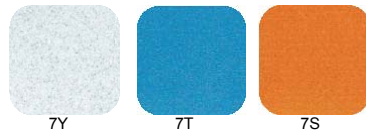

**Delight by Tecnoforma srl**  
 53036 Poggibonsi (SI) Italy  
 Via Umbria, 2/4  
 T. ++39 0577 980333  
 F. ++39 0577 938090  
[tecnoforma@delight.it](mailto:tecnoforma@delight.it)  
[www.delight.it](http://www.delight.it)

**Showroom**  
 20122 Milano Italy  
 Via Felice Cavallotti, 15  
 T. ++39 02 76018061  
 F. ++39 02 76406579  
[segismilano@segis.it](mailto:segismilano@segis.it)

# BIP

## B200PA

Floor standing lamp.  
Steel structure and powder coated aluminium sheet.  
Soles in shockproof polystyrene, fixing hands in nylon.  
Diffuser in transparent plastic material.  
Connection E27, max 150 Watt.  
Dimmer switch included.

## B100D3 / \*B200D3 /

## B100D4 / \*B200D4

Single or double sided floor stand, designed to house newspapers or leaflets, with pocket sections made of Plexiglas (\*).  
Steel structure and powder coated aluminium sheet.  
Soles in shockproof polystyrene, fixing hands in nylon.  
Available version with three holders for A4 size or with four holders for smaller sizes.

## B200PD / \*B200VS

Double sided communication floor stand with leaflets holder.  
Steel structure and powder coated aluminium sheet.  
Soles in shockproof polystyrene, fixing hands in nylon.  
Panel has a reusable adhesive area for ease in positioning sheets and a Plexiglas sheet protection.  
Available ash tray version (\*) with removable holder.



Art. B200PA  
Net weight: kg. 9  
Packing: 1 piece

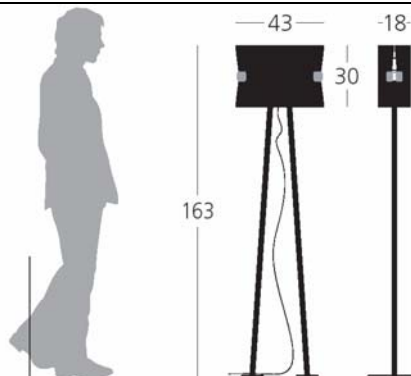

Delight by Tecnoforma srl  
53036 Poggibonsi (SI) Italy  
Via Umbria, 2/4  
T. ++39 0577 980333  
F. ++39 0577 938090  
[tecnoforma@delight.it](mailto:tecnoforma@delight.it)  
[www.delight.it](http://www.delight.it)

Showroom  
20122 Milano Italy  
Via Felice Cavallotti, 15  
T. ++39 02 76018061  
F. ++39 02 76406579  
[segismilano@segis.it](mailto:segismilano@segis.it)

# BIP

**Art. B100D3**

Net weight: kg. 16  
Packing: 1 piece

**Art. B200D3\***

Net weight: kg. 20  
Packing: 1 piece

**Art. B100D4**

Net weight: kg. 16,5  
Packing: 1 piece

**Art. B200D4\***

Net weight: kg. 21  
Packing: 1 piece

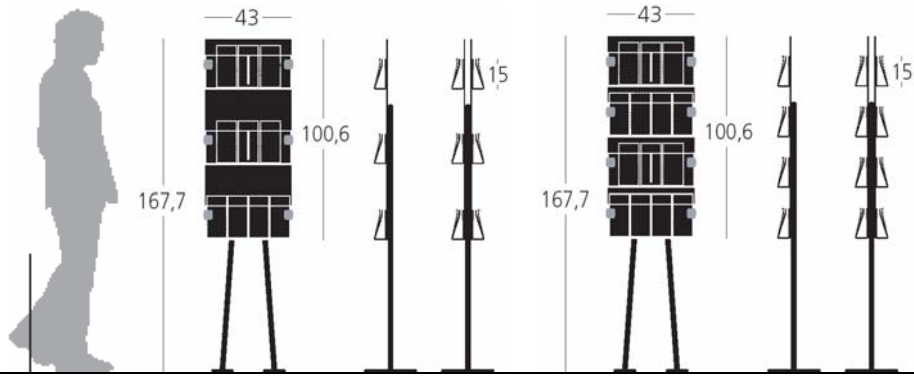

**Art. B200PD**

Net weight: kg. 9,2  
Packing: 1 piece

**Art. B200VS\***  
ash tray version (\*) with  
removable holder.

Net weight: kg. 9,2  
Packing: 1 piece

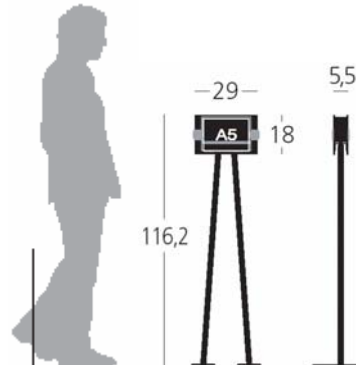

**Finishing:**

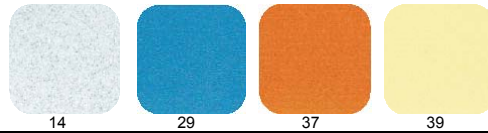

**Hands and soles colours:**

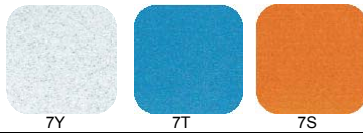

**Delight by Tecnoforma srl**  
53036 Poggibonsi (SI) Italy  
Via Umbria, 2/4  
T. ++39 0577 980333  
F. ++39 0577 938090  
[tecnoforma@delight.it](mailto:tecnoforma@delight.it)  
[www.delight.it](http://www.delight.it)

**Showroom**  
20122 Milano Italy  
Via Felice Cavallotti, 15  
T. ++39 02 76018061  
F. ++39 02 76406579  
[segismilano@segis.it](mailto:segismilano@segis.it)

# BIP

## B100VE

Floor standing book rest with magnetic book holder.  
Steel structure and powder coated aluminium sheet.  
Soles in shockproof polystyrene.

## B100CL / \*B200CL

Single and double sided (\*) floor standing trestle.  
Steel structure and powder coated aluminium sheet.  
Soles in shockproof polystyrene, fixing hands in nylon.  
Adjustable height for orizontal and vertical panels 50x30 cm. and 100x70.  
B100CL/B200CL can be assembled with the following panels:  
C600LC/C600LG/C600LP (Capo Famiglia), B300PP or customer's own panel..

## B100LA

Floor standing black board with pencil holder.  
Steel structure and powder coated aluminium sheet.  
Soles in shockproof polystyrene.  
Writable white laminate panel and notebook holder of cm 70x100.



**Art. B100VE**  
Net weight: kg. 9  
Packing: 1 piece

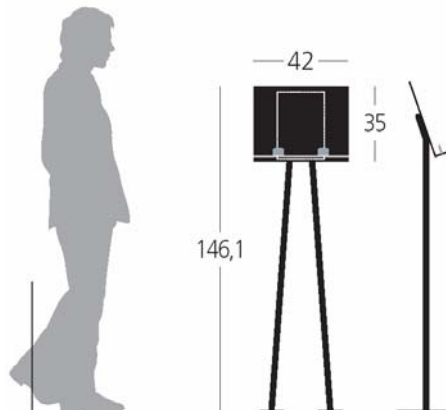

**Art. B100CL**  
Net weight: kg. 17,2  
Packing: 1 piece

**Art. B200CL\***  
Net weight: kg. 17,2  
Packing: 1 piece

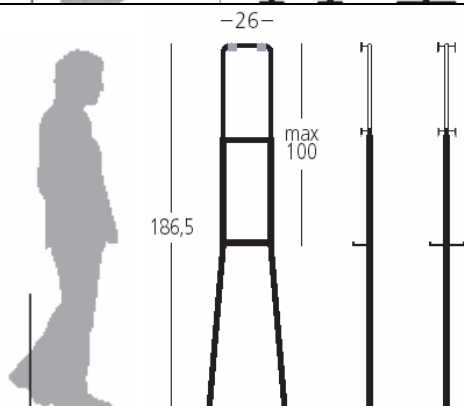

**Delight by Tecnoforma srl**  
53036 Poggibonsi (SI) Italy  
Via Umbria, 2/4  
T. ++39 0577 980333  
F. ++39 0577 938090  
[tecnoforma@delight.it](mailto:tecnoforma@delight.it)  
[www.delight.it](http://www.delight.it)

**Showroom**  
20122 Milano Italy  
Via Felice Cavallotti, 15  
T. ++39 02 76018061  
F. ++39 02 76406579  
[segismilano@segis.it](mailto:segismilano@segis.it)

# BIP

Art. B100LA  
Net weight: kg. 17,2  
Packing: 1 piece – n° 2 boxes

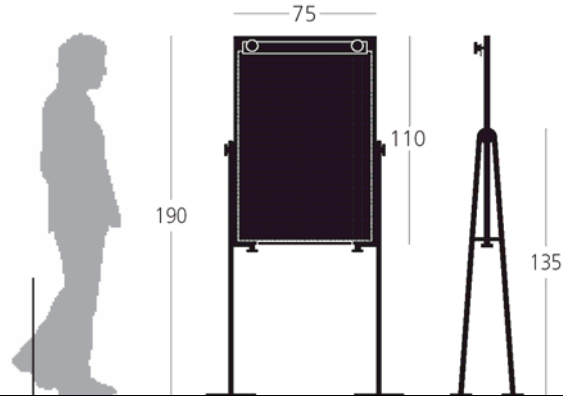

**Finishing:**

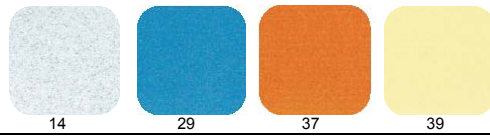

**Hands and soles colours:**

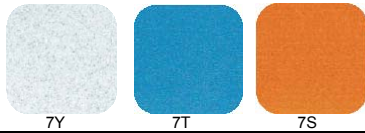

**Delight by Tecnoforma srl**  
53036 Poggibonsi (SI) Italy  
Via Umbria, 2/4  
T. ++39 0577 980333  
F. ++39 0577 938090  
[tecnoforma@delight.it](mailto:tecnoforma@delight.it)  
[www.delight.it](http://www.delight.it)

**Showroom**  
20122 Milano Italy  
Via Felice Cavallotti, 15  
T. ++39 02 76018061  
F. ++39 02 76406579  
[segismilano@segis.it](mailto:segismilano@segis.it)

# BIP

## B200DS

Umbrella's bags dispenser.  
Steel structure and powder coated aluminium sheet.  
Soles in shockproof polystyrene.  
Horizontal support temporarily holds one umbrella.  
Rolls with pre-cut bags can be customized with customers own logo.



Art. B200DS  
Net weight: kg. 17  
Packing: 1 piece

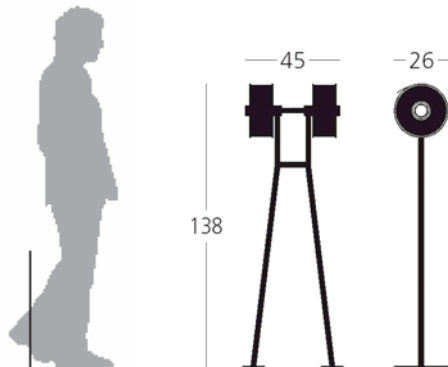

### Finishing:

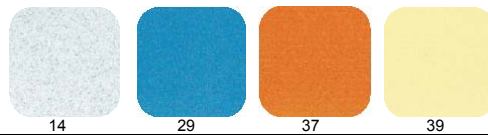

### Hands and soles colours:

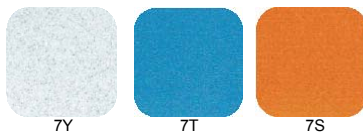

### Accessories:

Roll of nr. 300 PE LD white bags, including printing and pre-cutting art. B200SA



Delight by Tecnoforma srl  
53036 Poggibonsi (SI) Italy  
Via Umbria, 2/4  
T. ++39 0577 980333  
F. ++39 0577 938090  
[tecnoforma@delight.it](mailto:tecnoforma@delight.it)  
[www.delight.it](http://www.delight.it)

Showroom  
20122 Milano Italy  
Via Felice Cavallotti, 15  
T. ++39 02 76018061  
F. ++39 02 76406579  
[segismilano@segis.it](mailto:segismilano@segis.it)