

**viccarbe**

# Sistema Armchair

---

Designed by Lievore Altherr Molina

Technical info - EN

**LOUNGE CHAIR SUGGESTIONS**

**COMPOSITION 1**

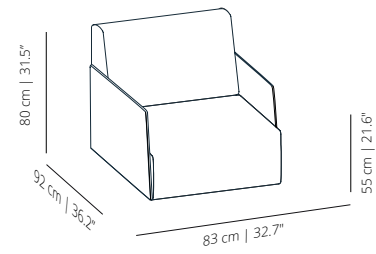

**COMPOSITION 2**

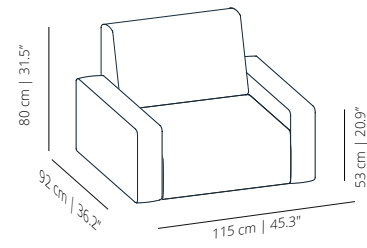

**COMPOSITION 3**

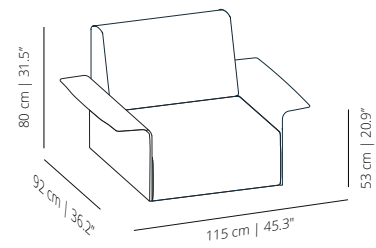

**COMPOSITION 4**

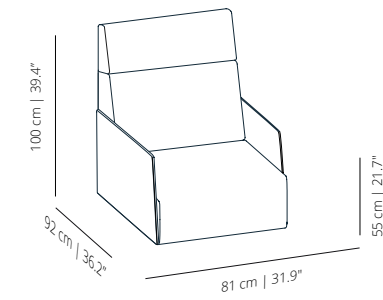

**COMPOSITION 5**

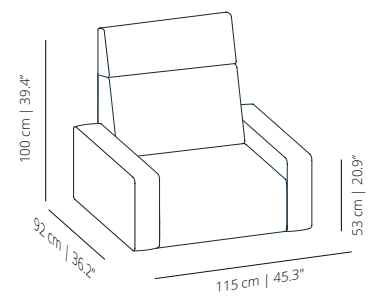

**COMPOSITION 6**

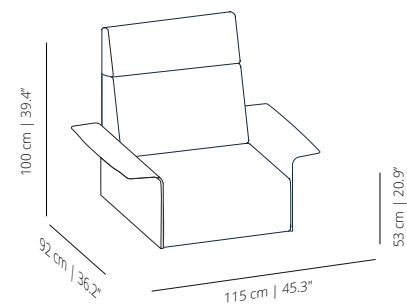

**BACKREST OPTIONS**

**SISSR**  
backrest modules

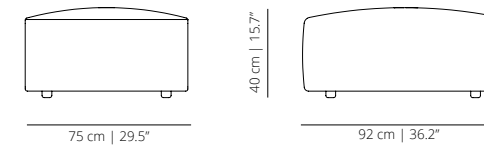

**SISM**  
medium backrest module

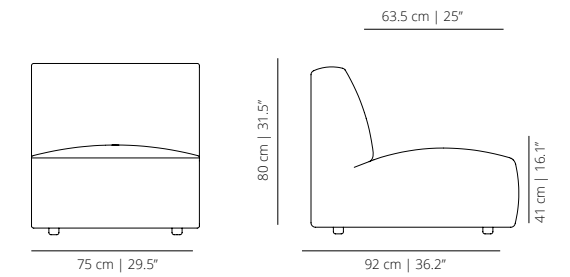

**SISA**  
high backrest module

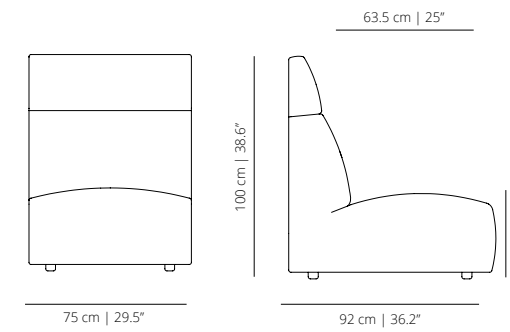

**ARM OPTIONS**

**SISBRF**  
narrow arm

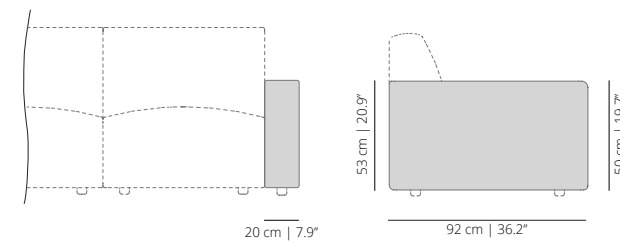

**SISBRG**  
wide arm

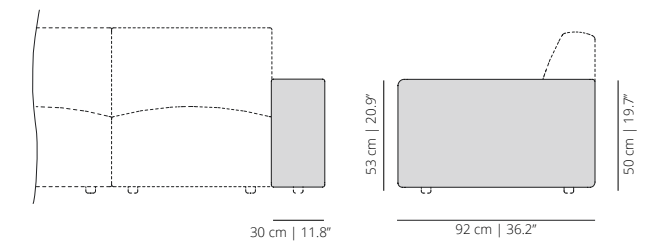

**ARM OPTIONS**

**SISBRME**  
medium backrest module

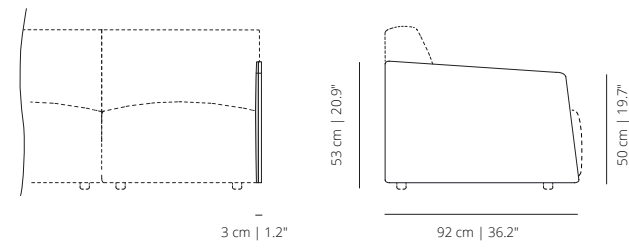

**SISBRMEC**  
medium backrest module

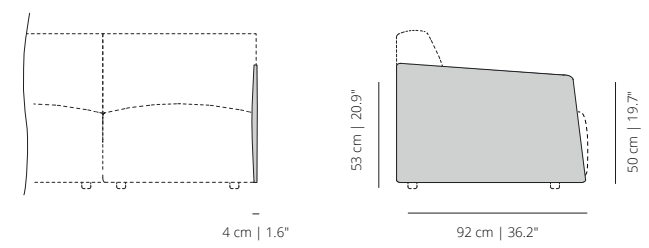

**SISBRM**  
curved wooden and/or upholstered arm

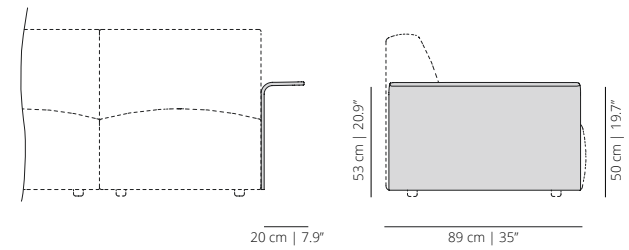

**ACCESSORIES**

**SISAL**  
cushion 60x30

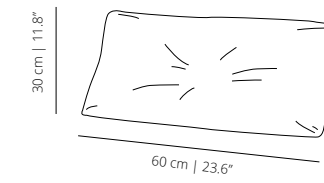

**SISAL**  
cushion 50x50

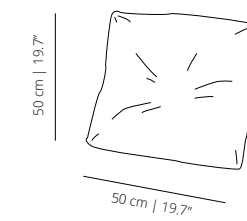

**SISRE**  
headrest

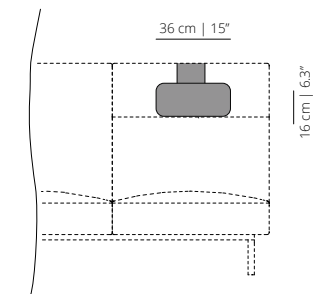

**POUFS SMOOTH & SOFT UPHOLSTERY**

**SISPOR | SISPORS**  
round pouf

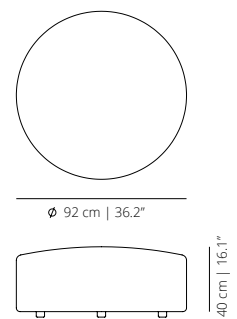

**SISPOC | SISPOCS**  
squared pouf

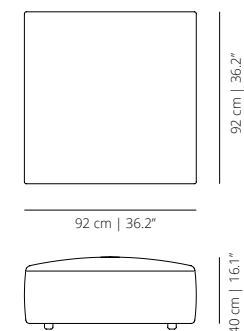

Upholstered modules that allow angular or straight compositions.

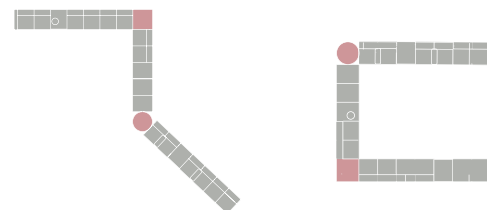

LOUNGE CHAIR SUGGESTIONS

COMPOSITION 1

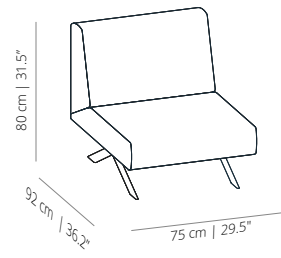

COMPOSITION 2

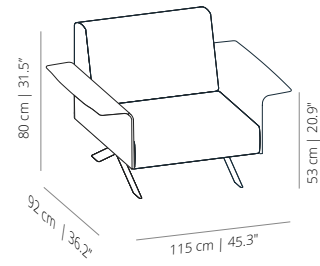

COMPOSITION 3

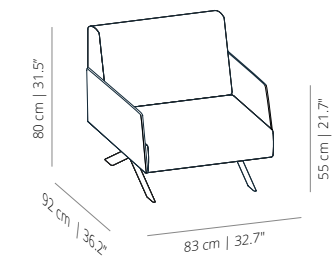

COMPOSITION 4

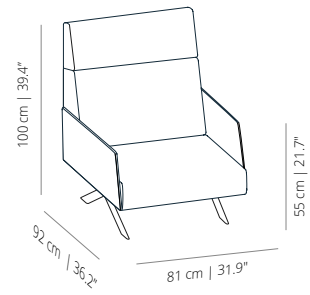

COMPOSITION 5

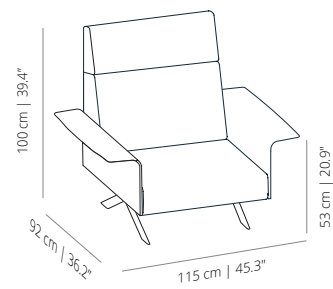

COMPOSITION 6

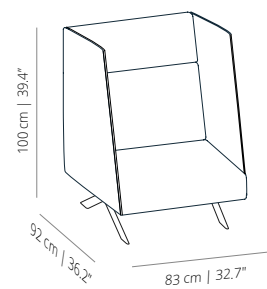

BACKREST OPTIONS

SISMP  
medium backrest module

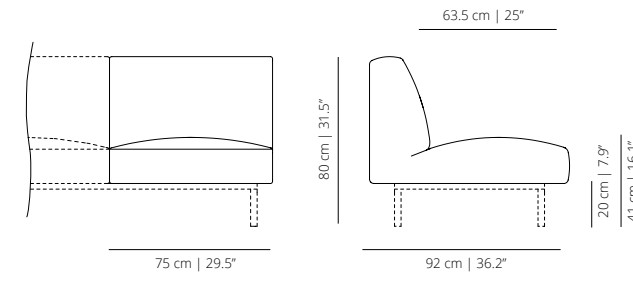

SISAP  
high backrest module

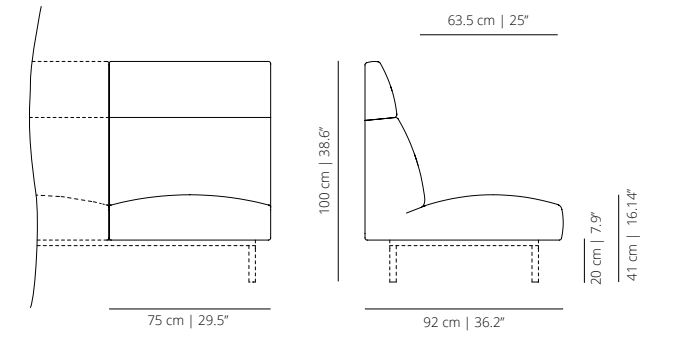

ARMS OPTIONS

SISBRMEP  
upholstered-wooden medium armrest

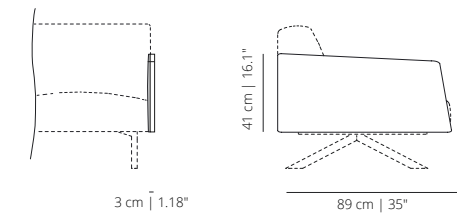

SISBRMECP  
fully upholstered medium armrest

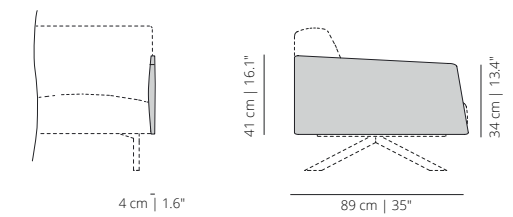

SISBRFP  
narrow arm

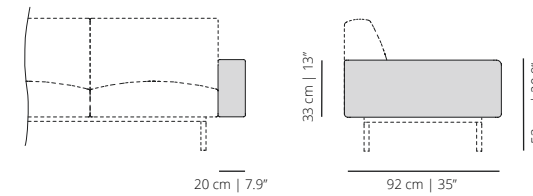

SISBRMP  
curved wooden and/or upholstered arm

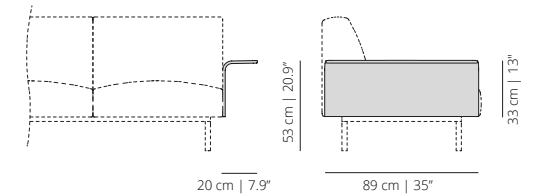

**ARM OPTIONS**

**SISBRH**  
upholstered-wooden high armrest

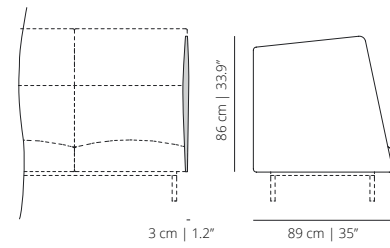

**SISBRHC**  
fully upholstered high armrest

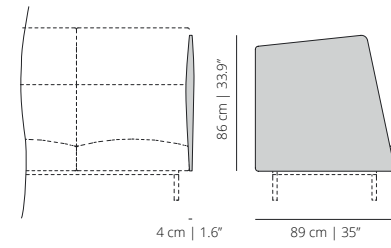

**LEGS OPTIONS**

**SISPTI**  
scissors legs

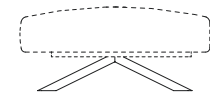

**SISPMET**  
cylinder legs



**SISPTI**  
scissors legs

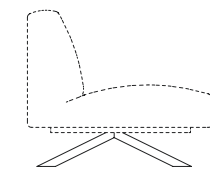

**SISPTITP**  
upholstered scissors legs

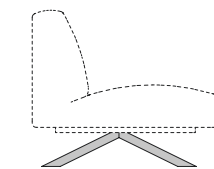

**LEGS OPTIONS**

**SISPMETTP | SISPMETTL**  
upholstered cylinder legs

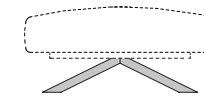

**ACCESSORIES & ELECTRIFICATIONS**

**SISAL30**  
cushion 60x30

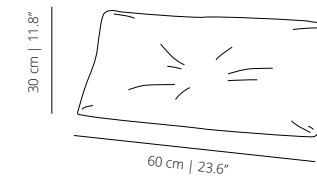

**SISAL50**  
cushion 50x50

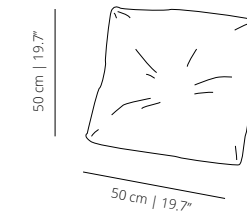

**SISRE**  
headrest

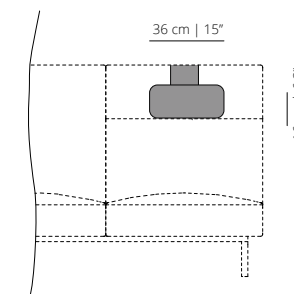

**SISEL**  
under seat powerbox

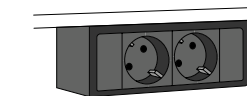

## FINISHES

### Upholstery

Check [upholstery](#) samples *for Indoor*.



Smooth upholstery



Soft upholstery

### ARMS | FLUTE LEGS

#### Stained Wood



bleached  
stained oak



matt  
stained oak



cognac  
stained oak



walnut  
stained oak



ash  
stained oak

### CILINDER LEGS | SCISSORS LEGS

#### Powder coated



white  
RAL 9003



black  
RAL 9005



taupe  
RAL 1019



orange flour  
RAL 2005

## TECHNICAL INFO

**Backrest** – Frame of calibrated steel base powder coated in thermoreinforced polyester in shadow. Interior structure in steel, solid wood and plywood. Woven seat and back structure. Polyester fibre covering. Expanded polyuretane foam in different densities. Fabric or leather.

Arm options:

**Narrow arm** – Wood structure covered with polyester fibre and non-deformable, expanded polyurethane foam of varying densities.

**Wide arm** – Wood structure covered with polyester fibre and non-deformable, expanded polyurethane foam of varying densities. With height equalising legs.

**Curved wood or upholstered arm** – Curved oak plywood arm, stained with the finishes of our collection or upholstered.

**Upholstered - wooden medium arm** – Armrest made of natural european oak plywood, stained in the finishes of our collection on the exterior, and upholstered on the interior.

**Fully upholstered medium arm** – Armrest made of natural european oak plywood upholstered on both sides.

**Upholstered-wooden high arm** – Natural plywood armrest stained with the finishes of our collection on the outside, and upholstered on the inside. Only compatible with high backrest modules.

**Fully upholstery high arm** – Natural plywood armrest, upholstered on both sides. Only compatible with high backrest modules.

Legs options:

**Cilinder legs** – Calibrated steel tube powder coated with tempered polyester, in the finishes from our collection or upholstered.

**Flute legs** – Wooden solid oak legs, with carvings on the sides, stained in the finishes from our collection.

**Scissors legs** – Calibrated steel tube powder coated with tempered polyester, in the finishes from our collection or upholstered.

Table options:

**Low table** – Table in lacquered microtexturized MDF or stained oak plywood with the finishes from our collection.

**Wooden box table** – Table with a stained European oak plywood or lacquered microtexturized MDF tabletop in the finishes from our collection. Interior plywood cylinder lacquered with the finishes from our collection.

-

**Cushions** – Cushions made of 100% siliconized high performance microfiber with anti-dust mite treatment.  
Dimensions: 50x50 cm | 60x30 cm.

**Headrest** – Accessorie that adapts perfectly to the shape of the backrest, enhancing comfort in situations when prolonged rest is needed. It requires no installation and is available in all the fabrics of our collection. Only available for modules with high backrest.

*NOTE 1: There is no possible to combine smooth upholstery modules and soft upholstery modules.*

## CERTIFICATIONS

ANSI/BIFMA X5.4-2012 and UNE EN 16139:2013

## Let's talk

We want to help you find the best designs for your project. Contact us and our team will get back to you as soon as possible.

CONTACT US

