

TRESTLE by John Pawson 2014



With his usual elegance, Pawson surprises us once again with this bench and table of exquisite proportions.

Ideal both for the home - in its short version - and for waiting areas and hallways in smart public spaces.

JOHN PAWSON



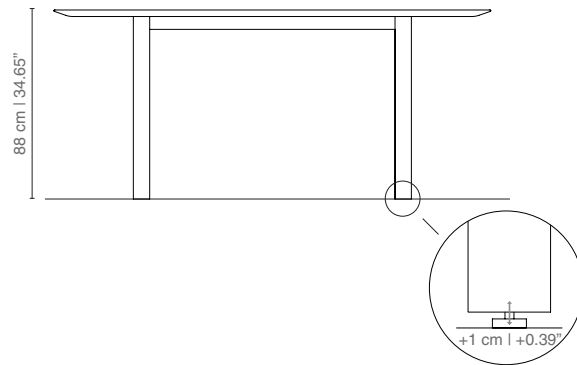
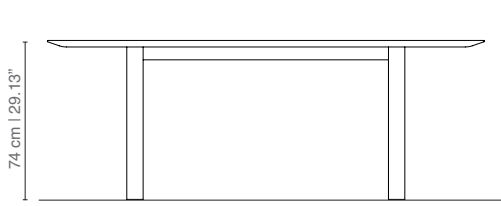
John Pawson was born in 1949 in Halifax, Yorkshire. After a period in the family textile business he lived for a number of years in Japan, moving to Tokyo towards the end of his stay, where he visited the studio of Japanese architect and designer Shiro Kuramata. Following his return to England, he enrolled at the Architecture Association in London, leaving to establish his own practice in 1981.

From the outset Pawson's work has focused on ways of approaching fundamental problems of space, proportion, light and materials - themes he also explored in his book *Minimum*, which examines the notion of simplicity in art, architecture and design across a variety of historical and cultural contexts. Early commissions included homes for the writer Bruce Chatwin, opera director Pierre Audi and collector Doris Lockhart Saatchi, together with art galleries in London, Dublin and New York.

While private houses have remained a consistent strand of the work, subsequent projects have spanned a wide range of scales and typologies, ranging from a bridge across a lake and a flagship store for Calvin Klein, to ballet sets, yacht interiors and a new Cistercian monastery in Bohemia. Pawson is currently working on the remodelling of the former Commonwealth Institute in London, which is scheduled to open as a new permanent home for the Design Museum in 2015.

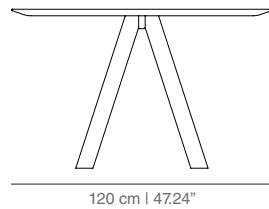
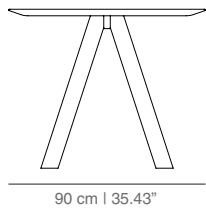
DIMENSIONS

Different measures available for the height of the table:



LEGS ADJUSTABLE HEIGHT

Different measures available for the width of the table top:



Thickness and type of table top edge:

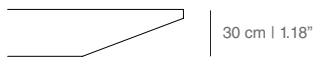
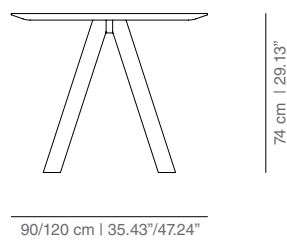
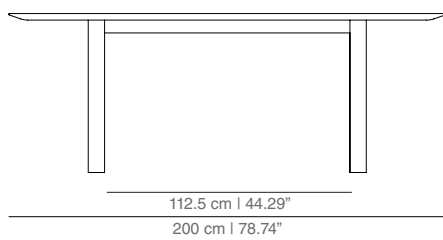
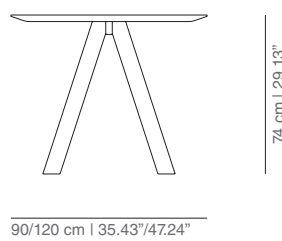
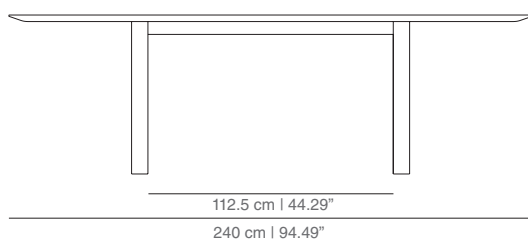


TABLE HEIGHT 74

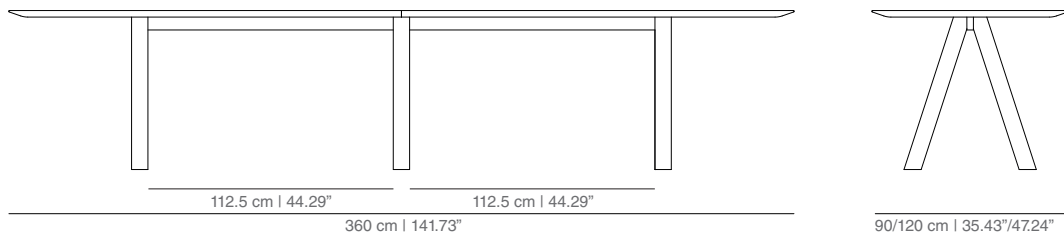
TRMSC simple table 200 width 90  
TRMSC\_A simple table 200 width 120



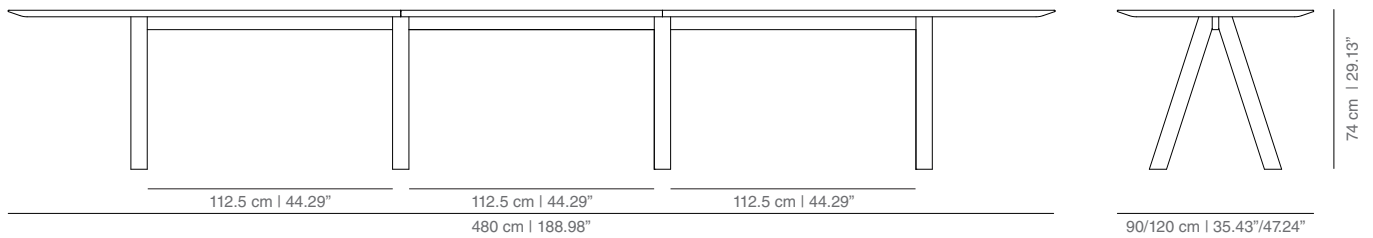
TRMS simple table 240 width 90  
TRMSA simple table 240 width 120



TRMD double table width 90  
TRMD\_A double table width 120

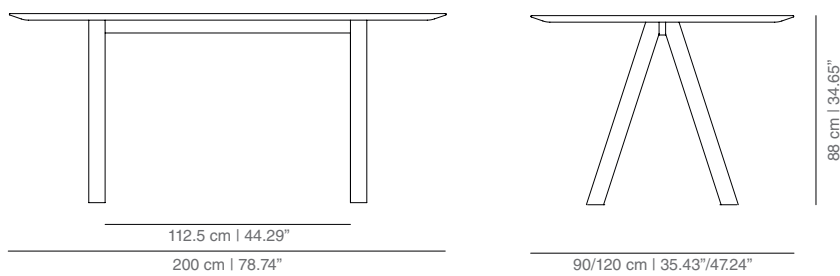


TRMT triple table width 90  
TRMT\_A triple table width 120

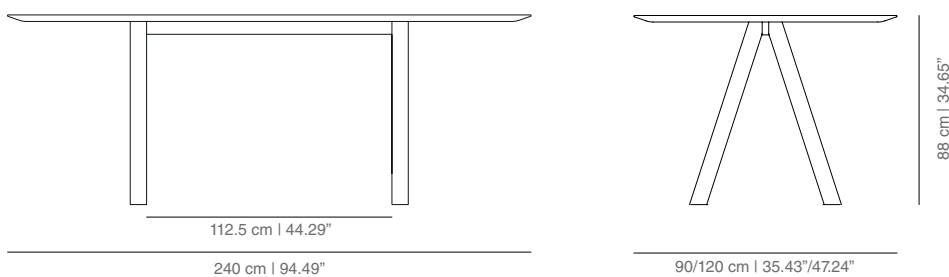


**TABLE HEIGHT 88**

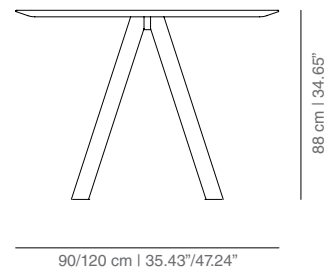
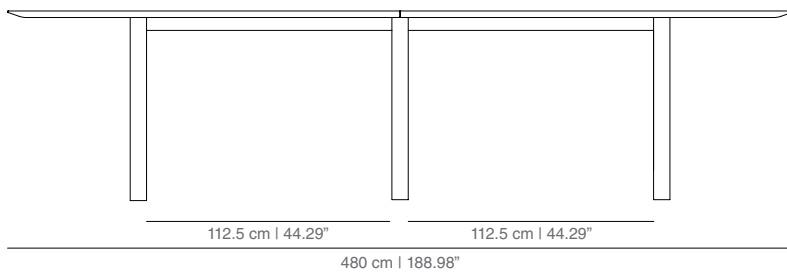
TRMSC\_H simple table 200 width 90  
TRSMC\_AH simple table 200 width 120



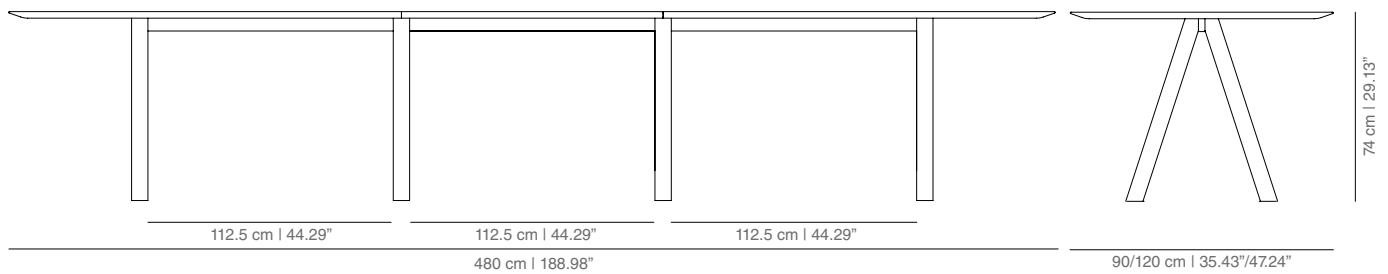
TRMS\_H simple table 240 width 90  
TRMS\_AH simple table 240 width 120



TRMD\_H double table width 90  
 TRMD\_AH double table width 120



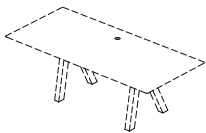
TRMT\_H triple table width 90  
 TRMT\_AH triple table width 120



**ACCESSORIES**

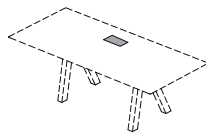
**AC03B conduit**

Cut out of the table top is included.



**TRMEC cut out**

Table top with incision to measure.



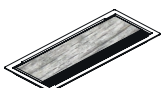
**CAP rectangular conduit**

Metallic access placket to the lower part of the table. Available in white, black or grey. Does not include electrifications.



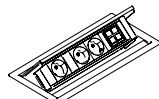
**CAPP rectangular conduit plus**

Metal access placket to the lower part of the table, for wooden table tops. Metal frame available in black or grey and central part in the veneer of the finish of the table. Does not include electrifications.



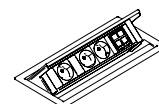
**BOX power box for tabletop**

Metal placket with 4 plugs or combined with integrated multimedia elements. Available in white, black or grey.

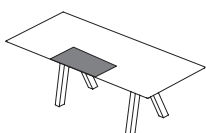


**BOXP power box plus for tabletop**

Metal placket with 4 plugs or combined with integrated multimedia elements, for wooden table tops. Metal frame available in black or grey and central part in the veneer of the finish of the table.



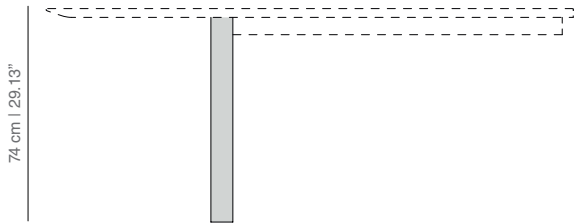
**PROT table top protector in eco leather**



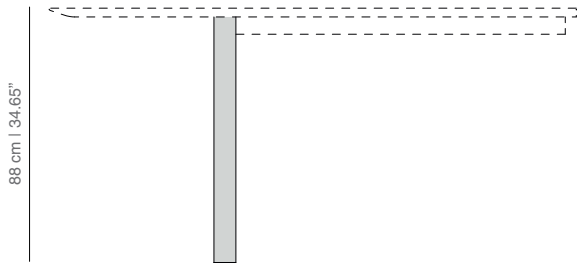
COMPONENTS FOR COMPOSITIONS OF TABLES

For different compositions to those suggested, is offered the possibility to create your own compositions. For all of them will have to choose two end table tops, central table tops according to the length of the table, and the legs (the number of legs will be the result of the number of total table tops plus 1).

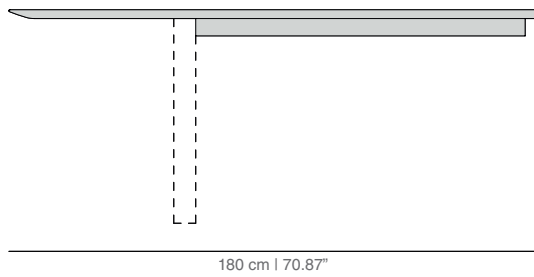
TRPM legs height 74



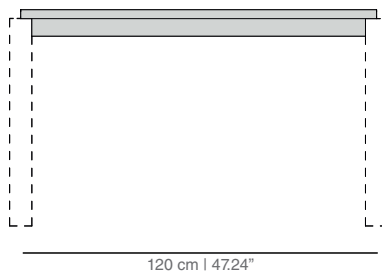
TRPMH legs height 88



TRME end table top L180 width 90  
TRMEA end table top L180 width 120

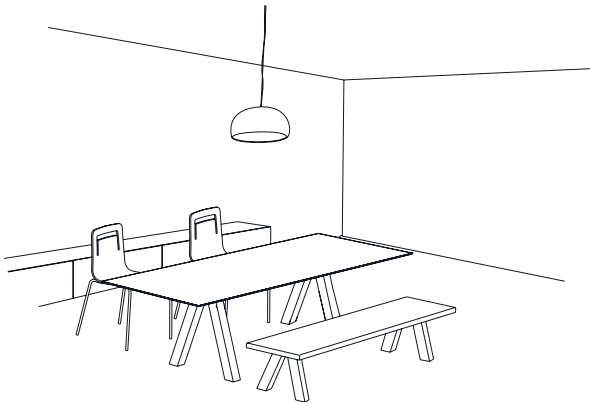


TRMC end table top L120 width 90  
TRMCA end table top L120 width 90

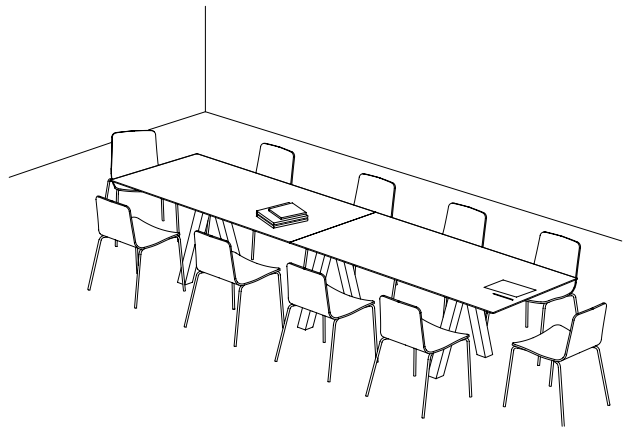
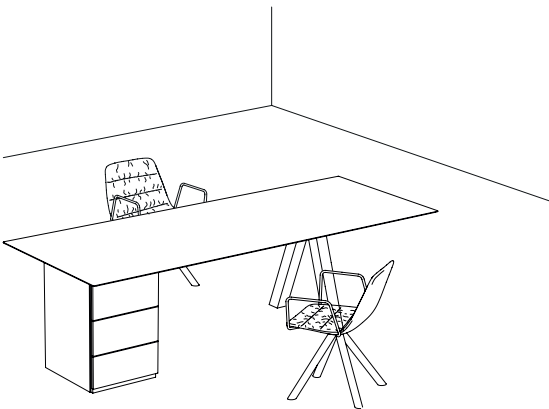


SUGGESTIONS

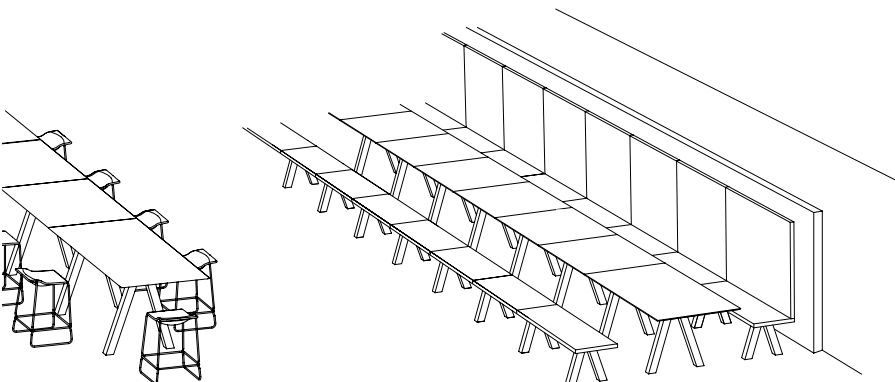
HOME



OFFICE



RESTAURANT



**TECHNICAL INFO**

The elegance of Pawson surprises us once again with this immense table and bench of exquisite proportions, for tables 74 cm height and 88 cm counter height.

The table top is available in two different finishes and width (90 cm and 120 cm):

- 30 mm MDF board with a natural oak veneer stained in matt, cognac, ash or wenge. Micro-textured lacquer in white, black, grey, sand or smoke also available.
- High pressure HPL laminate in white or black on a 30 mm thick MDF board with stained edges.

Stained solid oak or solid beech legs lacquered with the finishes from our collection.

**FINISHES**

**TABLE TOP**

Lacquered



White  
RAL 9003



Black  
RAL 9005



Grey  
RAL 7007



Sand  
NCS 3005Y50R



Smoke grey  
RAL 1019

HPL with MDF



White  
RAL 9003



Black  
RAL 9005

Stained (Oak Veneer)



Matt  
oak



Wenge



Cognac



Ash

**LEGS**

Lacquered (Beech)



White  
RAL 9003



Black  
RAL 9005



Grey  
RAL 7007



Sand  
NCS 3005Y50R



Smoke grey  
RAL 1019

Stained (Oak)



Matt  
oak



Wenge



Cognac



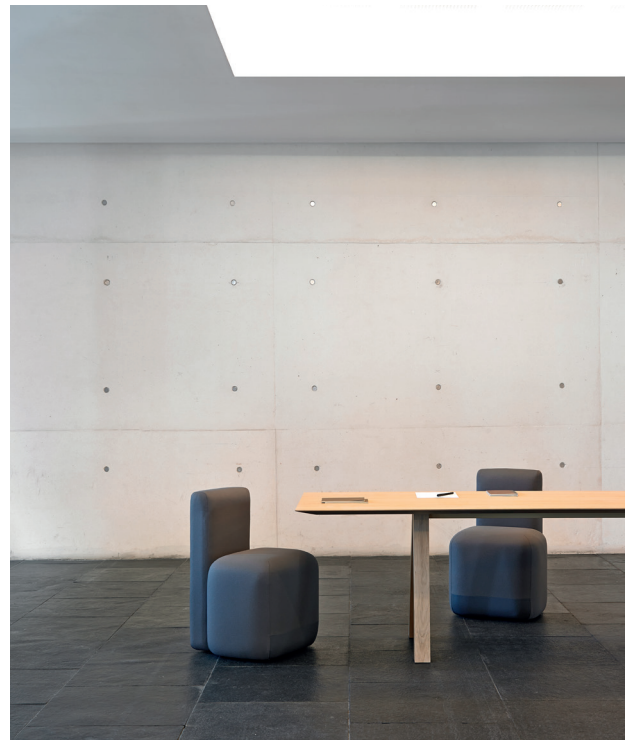
Ash

CERTIFICATE

UNE EN 527-1:11  
UNE EN 527-2-3:03  
ANSI - BIFMA X5.5:2014







PROJECTS

Joaquin Costa | Progetti | Stulens | Showroom Sydney | Hub Showroom | L'Antic Colonial Showroom | Buro Modern